

Remote Operation of a Farnsworth-Hirsch Fusor

Kyle Craft, Houghton College

Outline

- ▶ What is a Farnsworth-Hirsch Fusor?
- ▶ Why do we want to have a Farnsworth-Hirsch Fusor?
- ▶ Implementation of electronics
- ▶ Data from mass flow controller
- ▶ Results from operation with air
- ▶ Future work

Farnsworth-Hirsch Fusor

- ▶ Inertial electrostatic confinement
- ▶ Developed first by Philo T. Farnsworth and further developed by Robert Hirsch
- ▶ Patents from 1966 to 1970

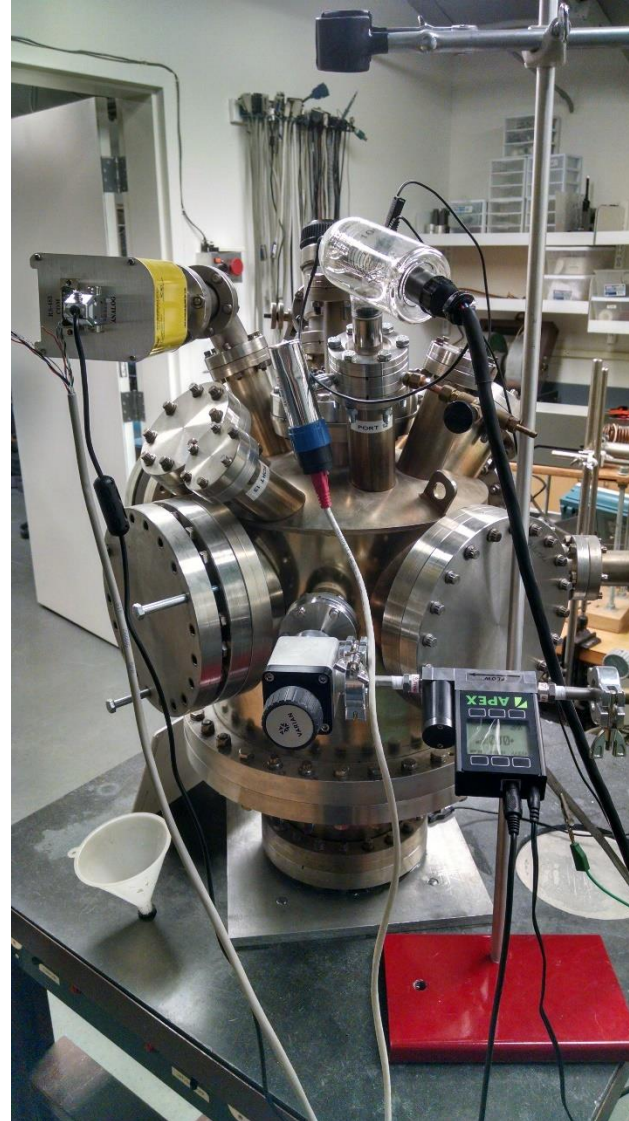

Inertial Electrostatic Confinement

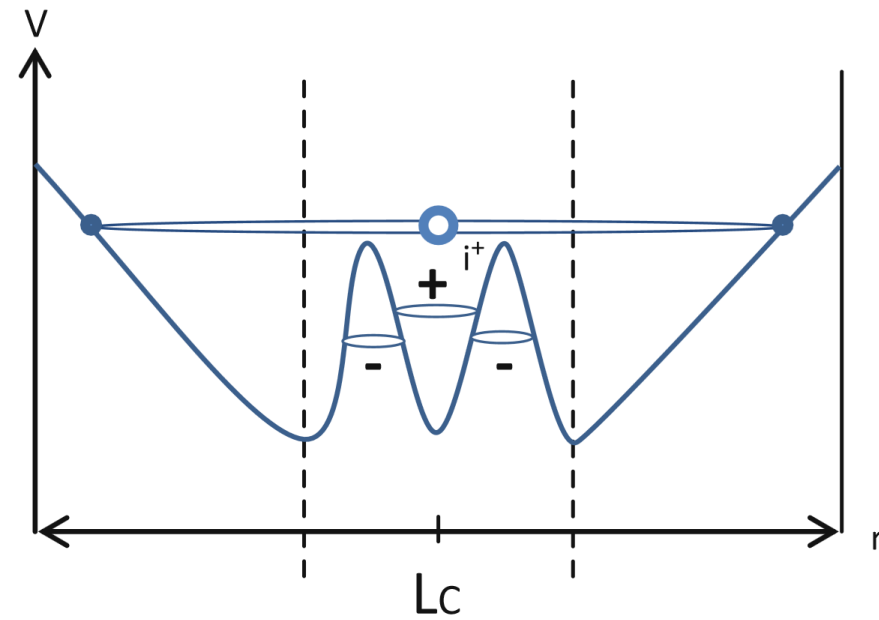
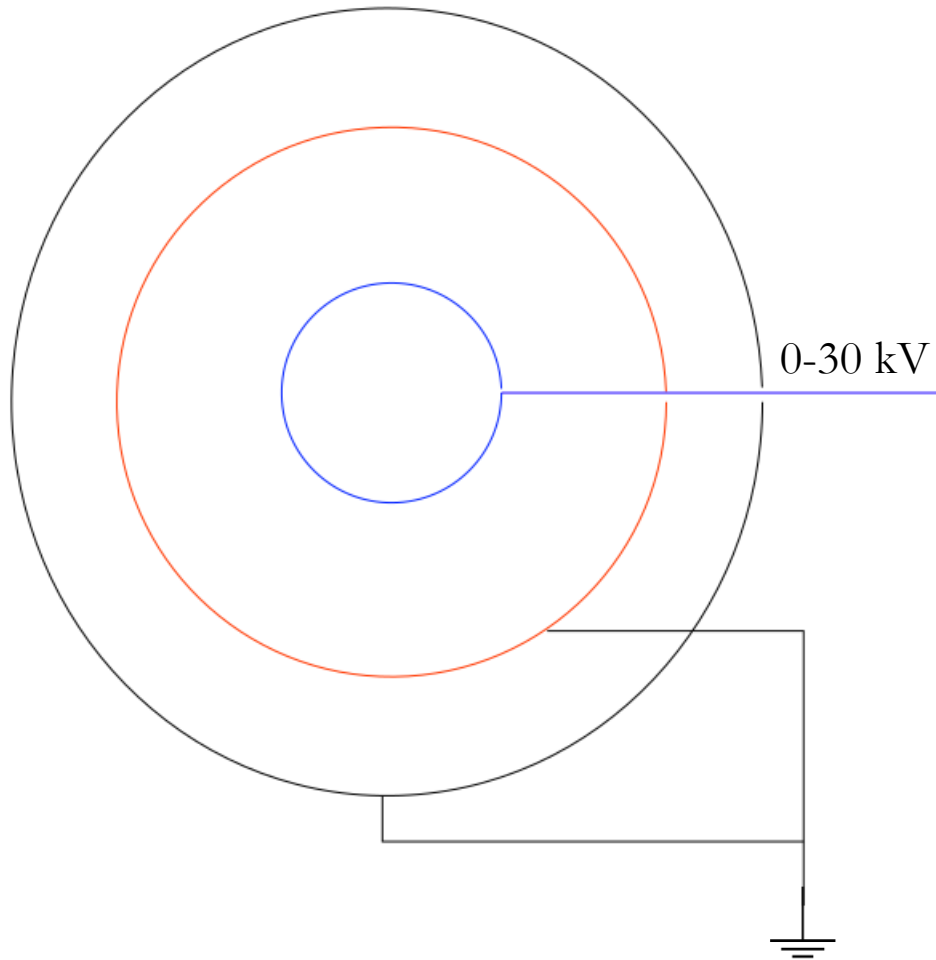

(Miley and Murali)

Motivation

- ▶ Study plasmas
- ▶ Study nuclear reactions
- ▶ Produce x-ray and neutrons

- ▶ Safety precautions
- ▶ Automation

Electronics Set-up

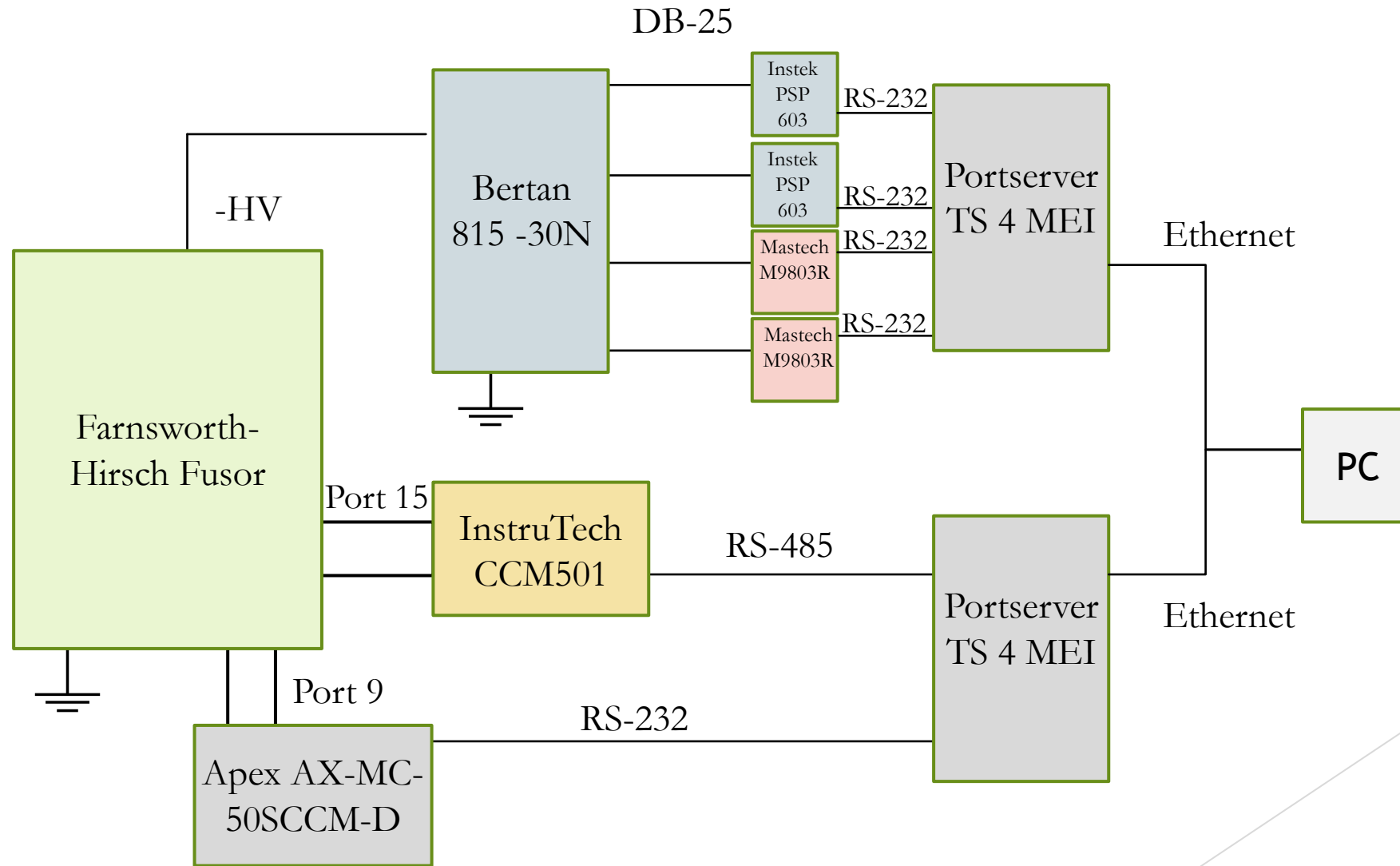

Fusor Controls

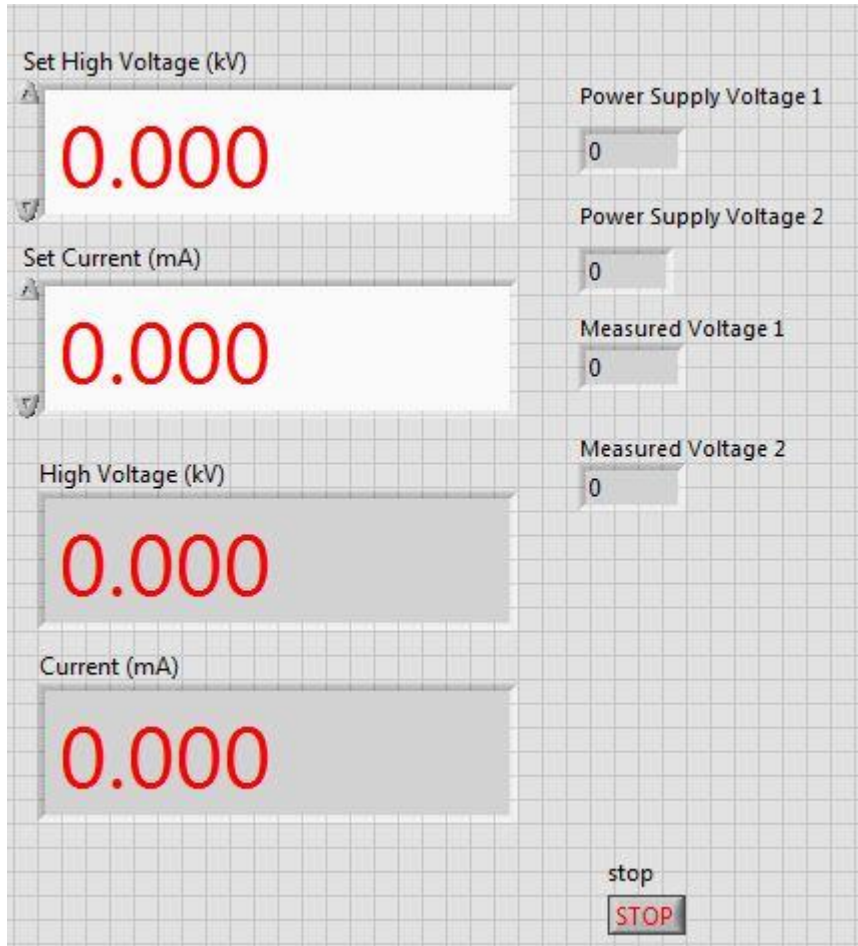

Set High Voltage (kV)
0.000

Set Current (mA)
0.000

High Voltage (kV)
0.000

Current (mA)
0.000

Power Supply Voltage 1
0

Power Supply Voltage 2
0

Measured Voltage 1
0

Measured Voltage 2
0

stop
STOP

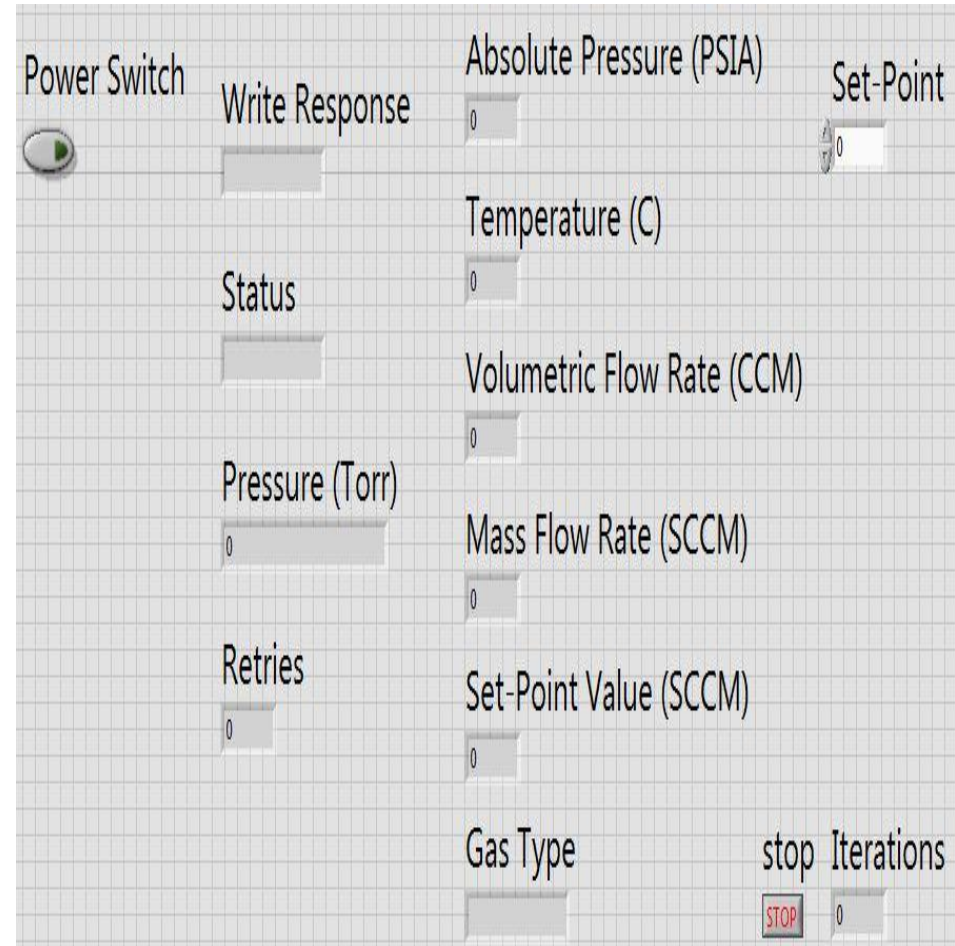

Power Switch

Write Response

Status

Pressure (Torr)
0

Retries
0

Absolute Pressure (PSIA)
0

Temperature (C)
0

Volumetric Flow Rate (CCM)
0

Mass Flow Rate (SCCM)
0

Set-Point Value (SCCM)
0

Gas Type

Set-Point

stop Iterations
STOP 0

Apex AX-MC-50SCCM-D Mass Flow Controller

Operating MFC Calibration

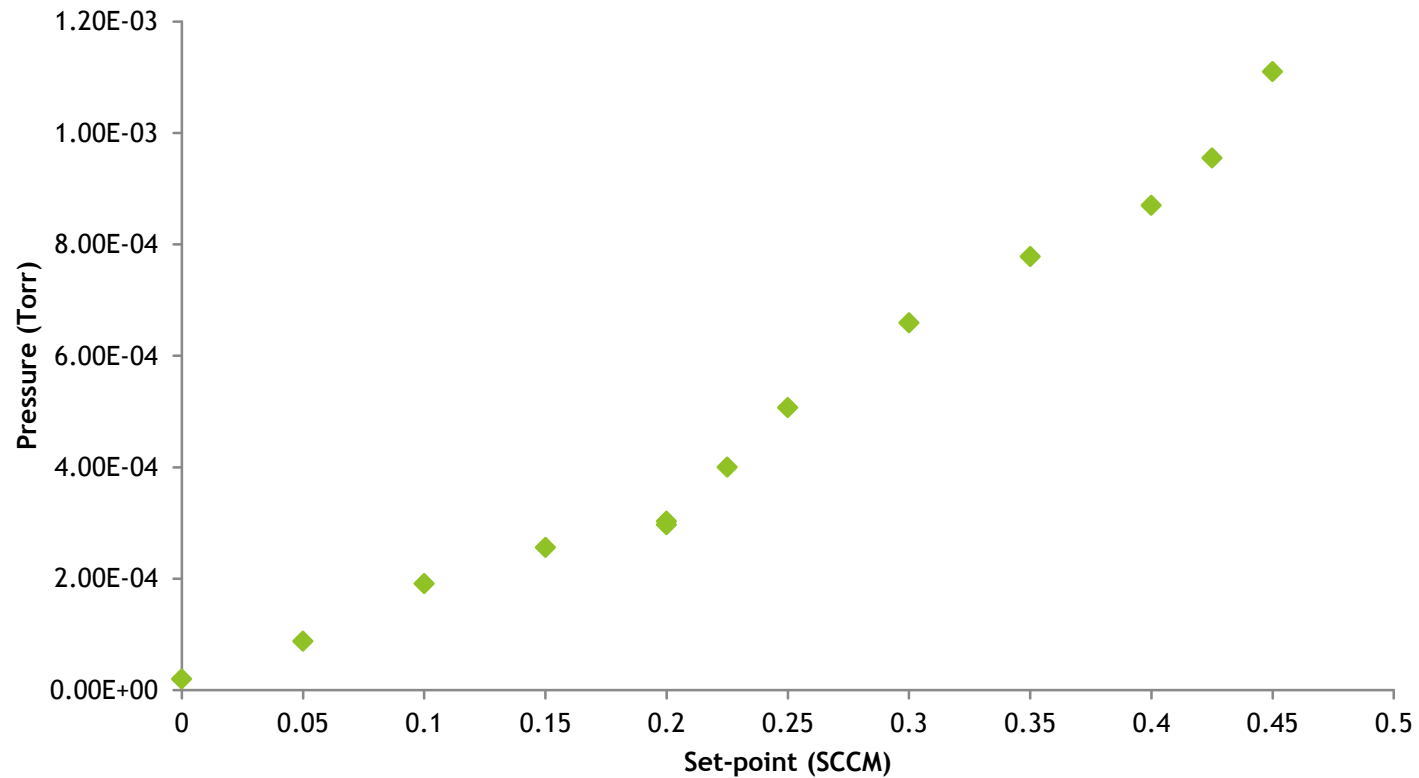

Results

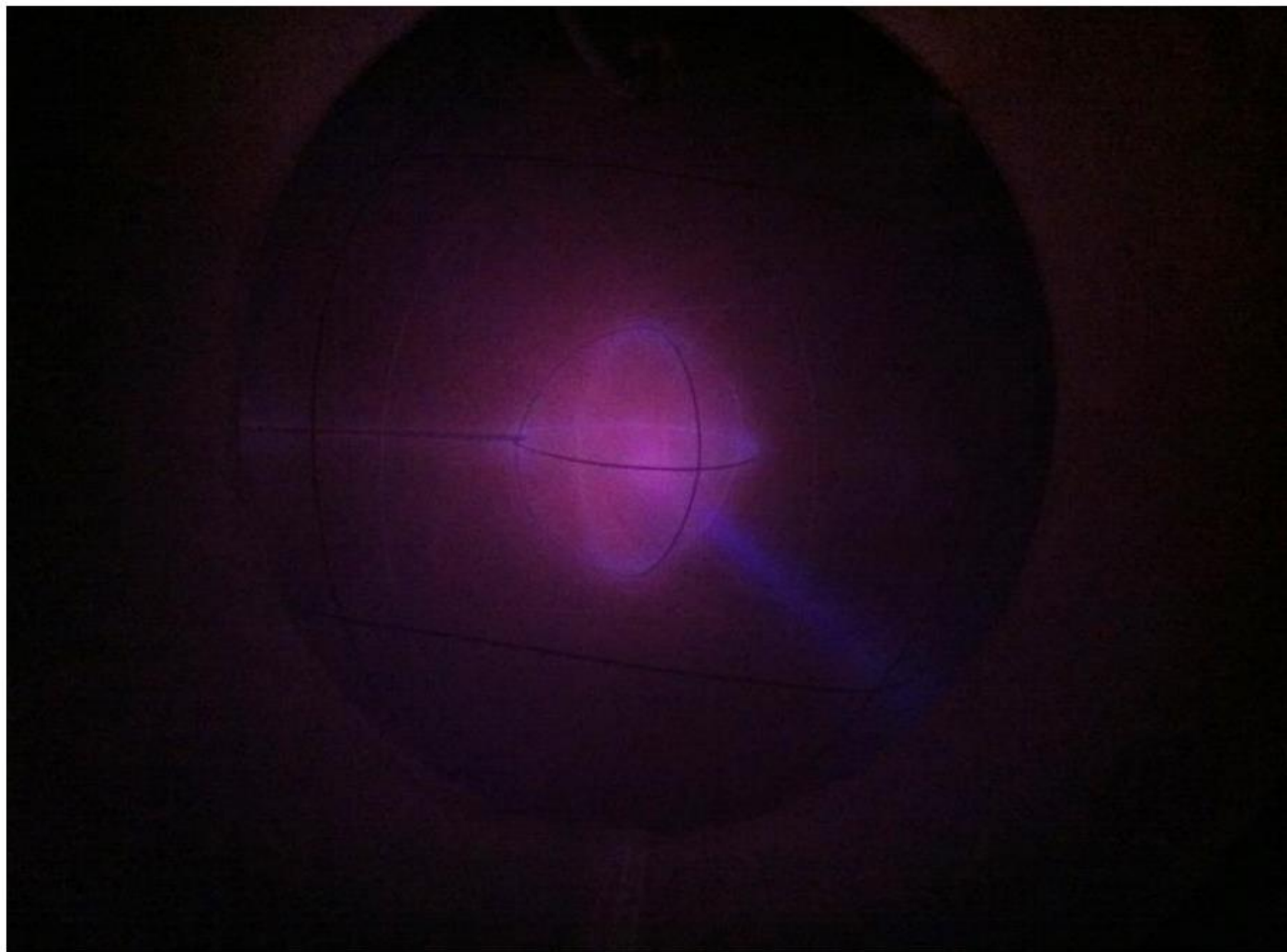

Results

Current vs. Voltage (4.8 mTorr)

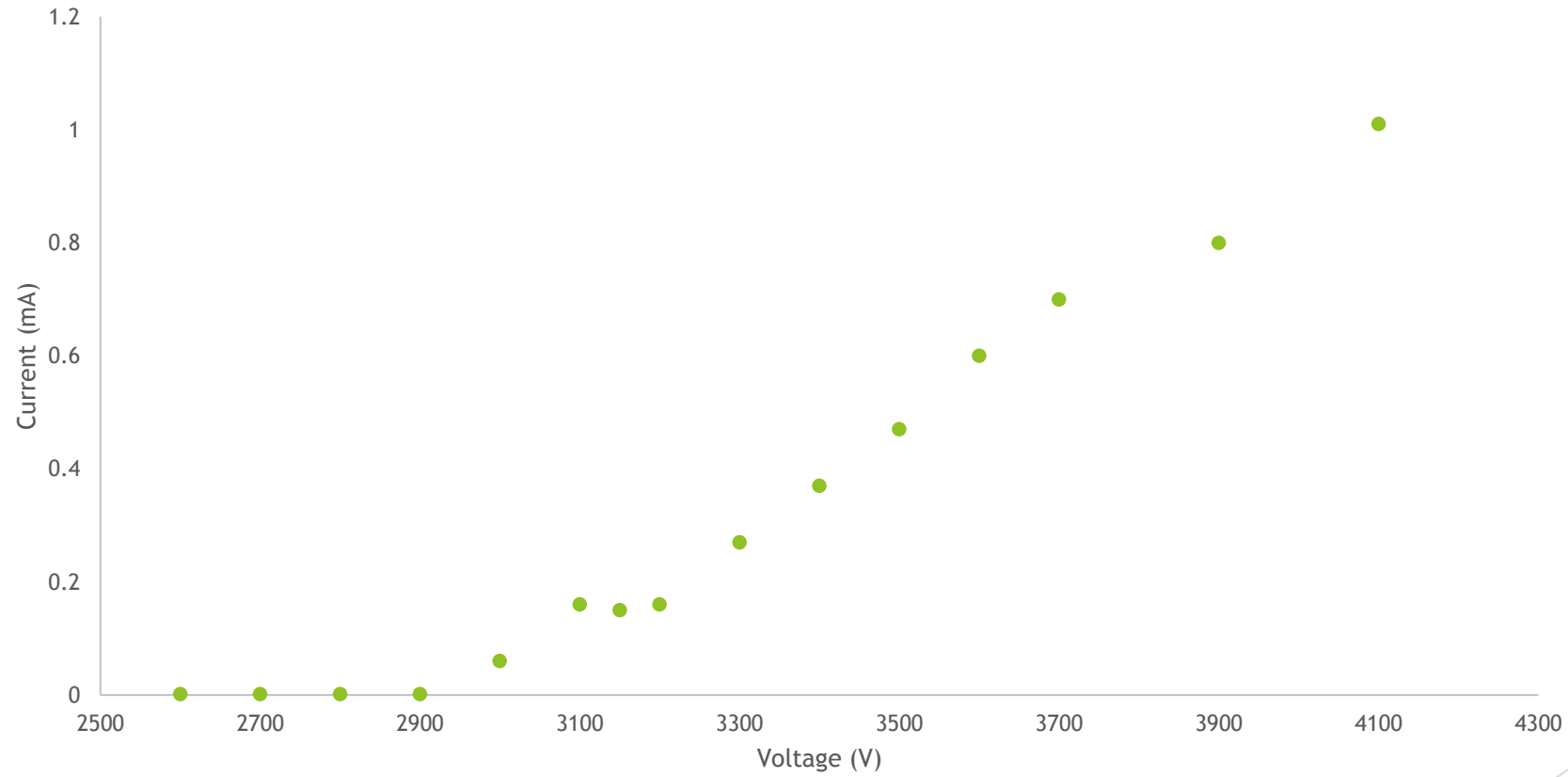

Results

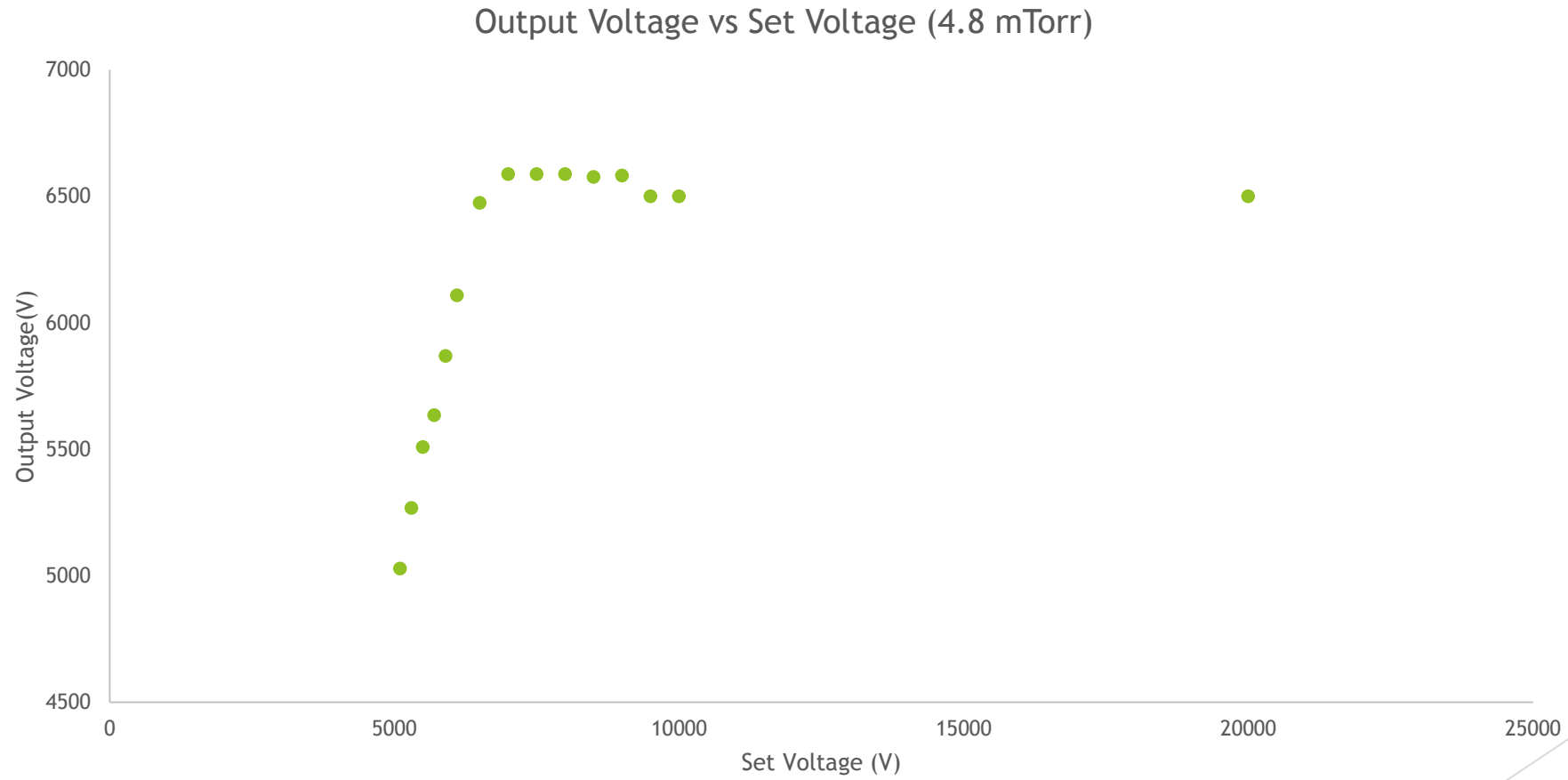

Results

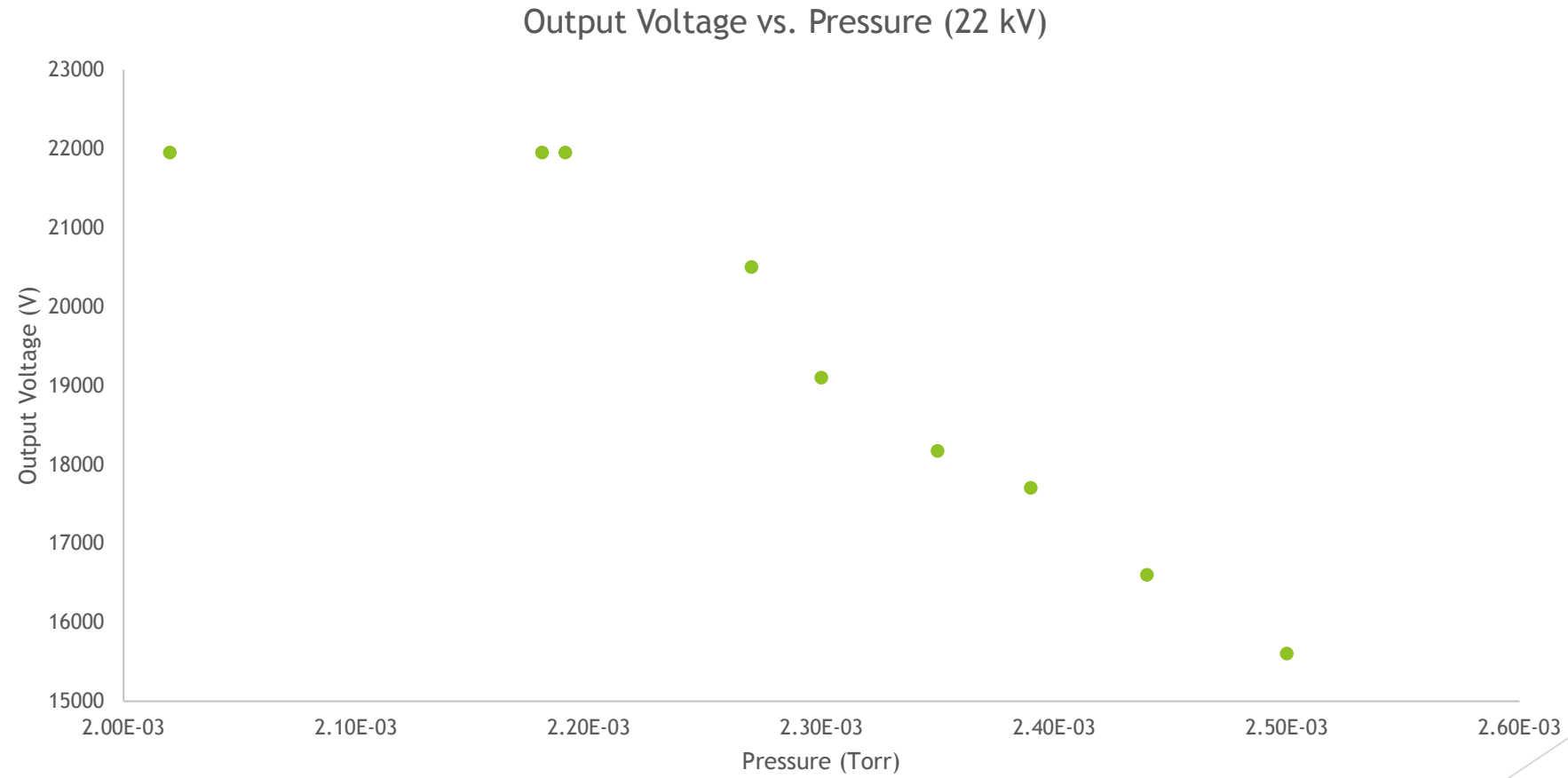

Future Work

- ▶ Sparking and discharge occurred with hydrogen in entrance to fusor
- ▶ Replace feedthrough to relocate discharge
- ▶ Operate with hydrogen for testing
- ▶ Operate with deuterium

References

- ▶ G.H. Miley and S.K. Murali, *Inertial Electrostatic Confinement Fusion: Fundamentals and Applications* (Springer, New York, 2014).